

TAPTITE 2000[®]

Thread Rolling Fasteners

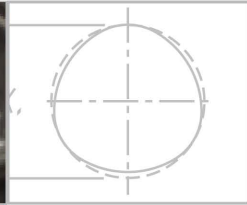
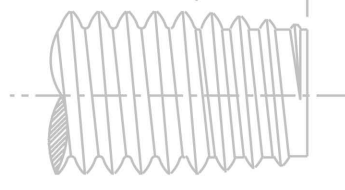
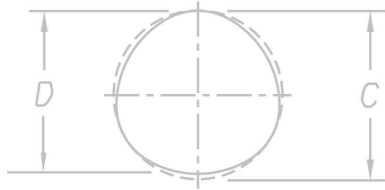

Leaders in Lowering the Cost of Assembly

TAPTITE 2000® Screws and Bolts



TAPTITE 2000® thread forming technology joins two unique concepts and advances fastener performance to new levels. TAPTITE® 2000™ fasteners afford end-users with enhanced opportunities to reduce the overall **Cost of Assembly**.

TAPTITE 2000® fasteners are designed to provide the benefits of prior Taptite® fastener products with an innovative new thread design — the **Radius Profile™ Thread**. The proven Trilobular™ principle is maintained while incorporating the Radius Profile™ thread. The result is a new generation of TAPTITE 2000® fasteners, which provides excellent mechanical, assembly, and ergonomic characteristics surpassed by no other technology.

Radius Profile™ Thread

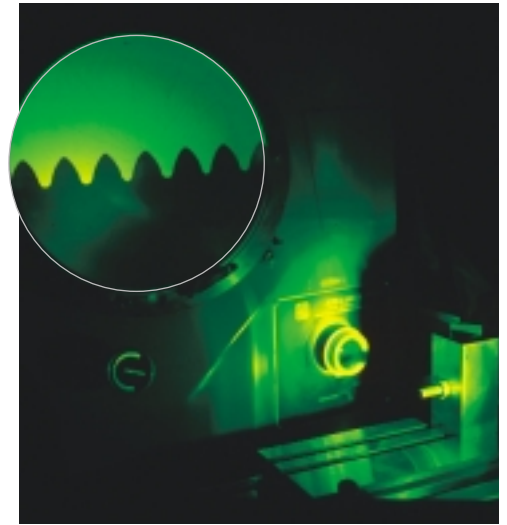

Lower Starting End Load
TAPTITE 2000® fasteners require low axial end load to initiate thread forming.

Higher Fail to Drive Ratio
The higher, more uniform, fail to drive ratio of TAPTITE 2000® bolts provides a built-in safety factor against over-torquing.

Prevailing Torque
The Trilobular™ shape of TAPTITE 2000® provides “prevailing torque”. Graph shows comparison of a TAPTITE 2000® fastener with IFI 524 locking screw specification.

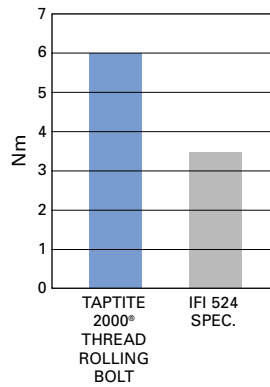
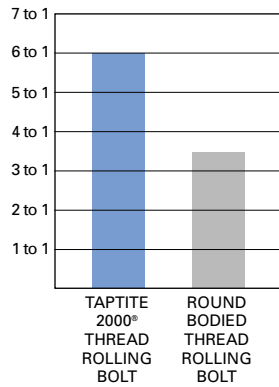
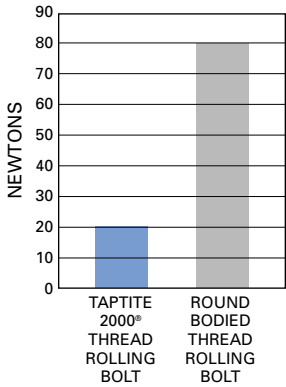

NOTE: End load and fail to drive ratio graphs shown are based on average results recorded when testing an M8 x 1.25 size in unthreaded steel weld nuts having a 7.45mm diameter hole. Prevailing torque test per IFI-524.



HEAT TAILORED FOR EXTRA TOUGHNESS

Pin-point precision of high hardness zone in axial section of a CORFLEX®-I fastener is shown by the crescent shaped areas in this chemically etched mount.

TAPTITE 2000® HEAT TREATMENT

TAPTITE 2000® bolts perform well in large diameter sizes in deep thread engagements. In the past, the limitations of case-hardened products restricted the exploitation of in-place cost savings for larger diameter Trilobular™ fasteners. However, TAPTITE 2000® screws and bolts are available with 3 different types of heat treatment: CORFLEX®-I, CORFLEX® N, and case hardened, making the fasteners adaptable to a wider variety of applications.

CORFLEX®-I Heat Treatment – CORFLEX®-I TAPTITE 2000® bolts are neutral hardened to grade strength, metric 8.8, 9.8, 10.9 or any intermediate value. The thread forming zone is selectively induction hardened in order to form threads in untapped nuts.

CORFLEX®-I heat treatment allows TAPTITE 2000® thread rolling bolts to provide in-place cost savings in large structural applications with strength, ductility and toughness equal to grade strength machine screws or bolts. CORFLEX®-I heat treatment to Grade 10.9 level is standard for TAPTITE® 2000™ bolts in sizes M6 (1/4") and larger.

CORFLEX®-N Heat Treatment – CORFLEX®-N TAPTITE 2000® fasteners are neutral hardened to grade 10.9 strength level. CORFLEX®-N products are designed to be used in “soft white” metals such as aluminum or zinc alloys. CORFLEX®-N heat treatment can be specified for any size TAPTITE 2000® screws or bolts that are intended to be used in aluminum or zinc alloys.

Case Hardening – Case hardening is the standard heat treatment for all TAPTITE 2000® screws in sizes M5 (#12) and smaller.



TAPTITE 2000® Screws and Bolts

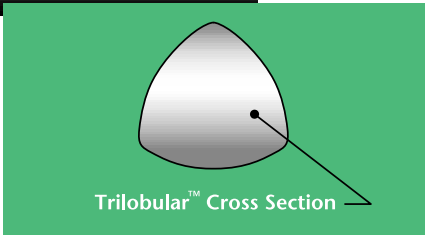
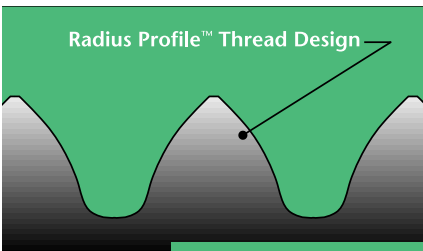
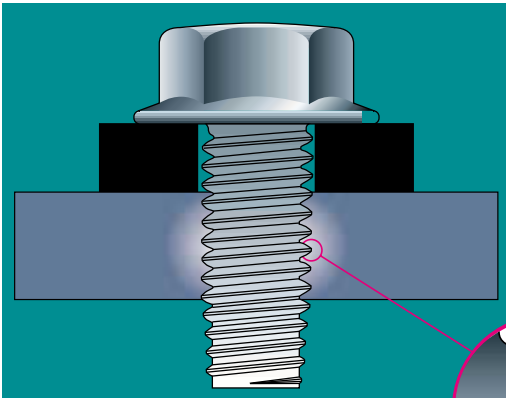

For M5/#12 and Smaller

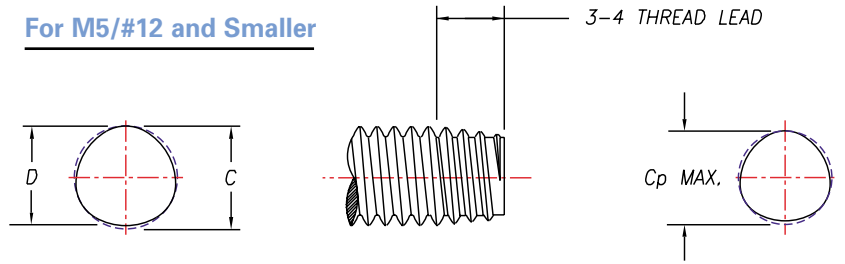

Radius Profile™ Thread Design

For M6/1/4" and Larger

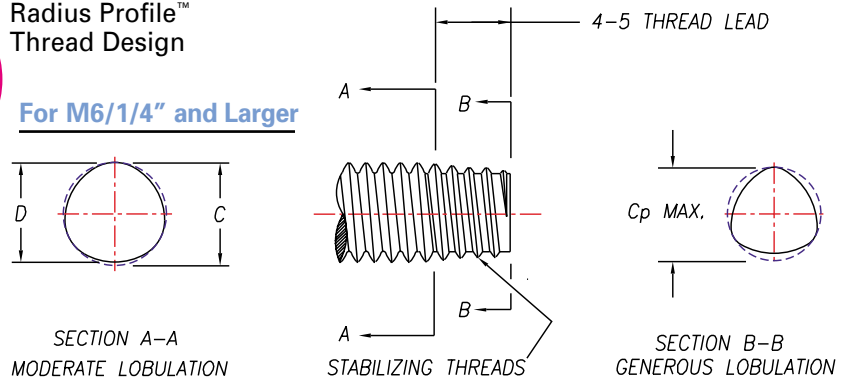

Advantages of the TAPTITE 2000® Fastener

- "Ergonomically" Friendly
- "Assembly" Friendly
- Superior Vibration Resistance
- Excellent Axial Alignment
- Low End Load
- High Strip-to-Drive Ratio
- High Prevailing Torque
- Excellent Torque Tension Relationship

Length Tolerance – Metric per ANSI B18.6.7M	
Nominal Screw Length	Tolerance on Length (mm)
to 3mm inclusive	±0.2
over 3 to 10mm inclusive	±0.3
over 10 to 16mm inclusive	±0.4
over 16 to 50mm inclusive	±0.5
over 50mm	±1.0

Length Tolerance – Inch per ANSI B18.6.3		
Nominal Screw Length	Nominal Screw Size	
	#4 - #12	1/4" - 1/2"
	Tolerance on Length (inches)	
To 1/2" inclusive	+0, - .020	+0, - .030
Over 1/2" to 1" inclusive	+0, - .030	+0, - .030
Over 1" to 2" inclusive	+0, - .060	+0, - .060
Over 2"	+0, - .090	+0, - .090

SCREW SIZE	SCREW BODY DIMENSIONS		Point Cp Max.
	C Nominal	D Nominal	
Metric Sizes (mm)			
M1.6 x 0.35	1.60	1.56	1.40
M2.0 x 0.40	2.00	1.96	1.77
M2.5 x 0.45	2.50	2.45	2.25
M3 x 0.5	3.00	2.95	2.71
M3.5 x 0.6	3.50	3.44	3.17
M4 x 0.7	4.00	3.93	3.60
M5 x 0.8	5.00	4.92	4.55
M6 x 1.0	6.00	5.90	5.38
M8 x 1.25	8.00	7.87	7.23
M10 x 1.5	10.00	9.85	9.08
M12 x 1.75	12.00	11.82	10.92
M14 x 2.0	14.00	13.80	12.77
M16 x 2.0	16.00	15.80	14.76
Inch Sizes (inches)			
2-56	0.086	0.084	0.077
3-48	0.099	0.097	0.088
4-40	0.112	0.110	0.098
5-40	0.125	0.123	0.111
6-32	0.138	0.135	0.121
8-32	0.164	0.161	0.147
10-24	0.190	0.186	0.167
10-32	0.190	0.187	0.174
12-24	0.216	0.212	0.193
1/4-20	0.250	0.245	0.220
5/16-18	0.313	0.307	0.279
3/8-16	0.375	0.369	0.337
7/16-14	0.438	0.431	0.394
7/16-20	0.438	0.433	0.407
1/2-13	0.500	0.492	0.453
9/16-12	0.563	0.555	0.511
5/8-11	0.625	0.616	0.569

TAPTITE 2000® Screws and Bolts



Recommended pilot hole sizes for TAPTITE 2000® Screws and Bolts at various percentages of thread engagement

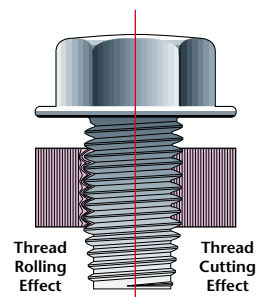

Metric Sizes (mm)

NOMINAL SCREW SIZE	PERCENT THREAD													
	100	95	90	85	80	75	70	65	60	55	50	45	40	35
	PILOT HOLE SIZES													
M2.5 x 0.45	2.21	2.22	2.24	2.25	2.27	2.28	2.29	2.31	2.32	2.34	2.35	2.37	2.38	2.40
M3 x 0.5	2.67	2.69	2.71	2.72	2.74	2.76	2.77	2.79	2.80	2.82	2.84	2.85	2.87	2.90
M3.5 x 0.6	3.11	3.13	3.15	3.17	3.19	3.21	3.23	3.25	3.27	3.29	3.30	3.32	3.34	3.36
M4 x 0.7	3.54	3.57	3.59	3.61	3.64	3.66	3.68	3.70	3.73	3.75	3.77	3.79	3.80	3.84
M4.5 x 0.75	4.01	4.04	4.06	4.09	4.11	4.13	4.16	4.18	4.21	4.23	4.26	4.28	4.30	4.33
M5 x 0.8	4.48	4.51	4.53	4.56	4.58	4.61	4.64	4.66	4.69	4.71	4.74	4.77	4.79	4.82
M6 x 1.0	5.35	5.38	5.42	5.45	5.48	5.51	5.54	5.58	5.61	5.64	5.67	5.71	5.74	5.77
M7 x 1.0	6.35	6.38	6.42	6.45	6.48	6.51	6.54	6.58	6.61	6.64	6.67	6.71	6.74	6.77
M8 x 1.25	7.19	7.23	7.27	7.31	7.35	7.39	7.43	7.47	7.51	7.55	7.59	7.63	7.67	7.72
M10 x 1.5	9.03	9.07	9.12	9.17	9.22	9.27	9.32	9.37	9.41	9.46	9.51	9.56	9.61	9.66
M12 x 1.75	10.86	10.92	10.98	11.03	11.09	11.15	11.20	11.26	11.31	11.37	11.43	11.49	11.55	11.60

Inch Sizes (inches)

NOMINAL SCREW SIZE	PERCENT THREAD													
	100	95	90	85	80	75	70	65	60	55	50	45	40	35
	PILOT HOLE SIZES													
2-56	0.0744	0.0750	0.0756	0.0761	0.0767	0.0773	0.0779	0.0785	0.0790	0.0796	0.0802	0.0808	0.0814	0.0819
3-48	0.0855	0.0861	0.0868	0.0875	0.0882	0.0888	0.0895	0.0902	0.0909	0.0916	0.0922	0.0929	0.0936	0.0943
4-40	0.0958	0.0966	0.0974	0.0982	0.0990	0.0998	0.1006	0.1014	0.1023	0.1031	0.1039	0.1047	0.1055	0.1063
5-40	0.1088	0.1096	0.1104	0.1112	0.1120	0.1128	0.1136	0.1144	0.1153	0.1161	0.1169	0.1177	0.1185	0.1193
6-32	0.1177	0.1187	0.1197	0.1207	0.1218	0.1228	0.1238	0.1248	0.1258	0.1268	0.1278	0.1289	0.1299	0.1309
8-32	0.1437	0.1447	0.1457	0.1467	0.1478	0.1488	0.1498	0.1508	0.1518	0.1528	0.1538	0.1549	0.1559	0.1569
10-24	0.1629	0.1643	0.1656	0.1670	0.1683	0.1697	0.1710	0.1724	0.1738	0.1751	0.1765	0.1778	0.1792	0.1805
10-32	0.1697	0.1707	0.1717	0.1727	0.1738	0.1748	0.1758	0.1768	0.1778	0.1788	0.1798	0.1809	0.1819	0.1829
12-24	0.1889	0.1903	0.1916	0.1930	0.1943	0.1957	0.1970	0.1984	0.1998	0.2011	0.2025	0.2038	0.2052	0.2065
1/4-20	0.2175	0.2191	0.2208	0.2224	0.2240	0.2256	0.2273	0.2289	0.2305	0.2321	0.2338	0.2354	0.2370	0.2386
5/16-18	0.2764	0.2782	0.2800	0.2818	0.2836	0.2854	0.2872	0.2890	0.2908	0.2926	0.2944	0.2963	0.2981	0.2999
3/8-16	0.3344	0.3364	0.3384	0.3405	0.3425	0.3445	0.3466	0.3486	0.3506	0.3527	0.3547	0.3567	0.3588	0.3608
7/16-14	0.3911	0.3934	0.3957	0.3980	0.4004	0.4027	0.4050	0.4073	0.4096	0.4120	0.4143	0.4166	0.4189	0.4213
1/2-13	0.4500	0.4525	0.4550	0.4575	0.4600	0.4625	0.4650	0.4675	0.4700	0.4725	0.4750	0.4775	0.4800	0.4825

EXAMPLE – The shaded area indicates that an M5 - 0.8 screw size in a 4.58 hole size provides 80% thread engagement. Because the above values are based on a linear relation between hole size and percentage thread engagement, the hole data becomes less accurate for engagements less than 70%.

Pilot Hole Tolerance - in terms of radial thread engagement, min hole = nominal hole + 10%, max hole = nominal - 5%.

Example: M8 - 1.25 in 6.0mm thick steel, nominal hole = 70% thread (7.43mm) per page 5 table.
Min. hole = 80% thread (7.35mm), max hole = 65% thread (7.47mm).



TAPTITE 2000® Screws and Bolts

Recommended pilot hole sizes for TAPTITE 2000® Screws and Bolts in steel nut members

Metric Sizes (mm)

Application Duty Class	Light 0.3 Diameter of Material			Medium-Light 0.5 Diameter of Material			Medium-Heavy 0.75 Diameter of Material			Full Strength 1.0 Diameter of Material			Extended 1.25 Diameter of Material		
	90%			80%			70%			65%			60%		
Percentage of Thread	Material Thickness	Pilot Hole	Drill Size	Material Thickness	Pilot Hole	Drill Size	Material Thickness	Pilot Hole	Drill Size	Material Thickness	Pilot Hole	Drill Size	Material Thickness	Pilot Hole	Drill Size
M2.5 x 0.45	0.5-0.9	2.24	2.25	0.9-1.5	2.27	#43 2.26	1.5-2.1	2.3	2.3	2.1-2.7	2.31	2.3	2.7-3.5	2.32	2.3
M3 x 0.5	0.5-1.1	2.71	#36 2.71	1.1-1.7	2.74	2.75	1.7-2.7	2.77	7/64 2.78	2.7-3.3	2.79	7/64 2.78	3.3-4.0	2.8	2.8
M3.5 x 0.6	0.6-1.4	3.15	1/8 3.18	1.4-2.0	3.19	3.2	2.0-2.9	3.23	3.25	2.9-3.8	3.25	3.25	3.8-4.5	3.27	#30 3.27
M4 x 0.7	0.8-1.4	3.59	3.6	1.4-2.4	3.64	#27 3.66	2.4-3.3	3.68	3.7	3.3-4.4	3.7	3.7	4.4-5.5	3.73	#26 3.73
M4.5 x 0.75	0.9-1.7	4.06	#21 4.04	1.7-2.7	4.11	4.1	2.7-3.9	4.16	4.2	3.9-4.9	4.18	4.2	4.9-6.4	4.21	4.2
M5 x 0.8	1.0-2.1	4.53	4.5	2.1-2.9	4.58	#15 4.57	2.9-4.4	4.64	#14 4.62	4.4-5.9	4.66	4.65	5.9-7.1	4.69	4.7
M6 x 1.0	1.2-2.4	5.42	#3 5.41	2.4-3.6	5.48	5.5	3.6-4.9	5.55	7/32 5.56	4.9-6.9	5.58	5.6	6.9-8.1	5.61	5.6
M7 x 1.0	1.4-2.4	6.42	6.4	2.4-4.4	6.48	6.5	4.4-6.5	6.55	F 6.53	6.5-7.7	6.58	6.6	7.7-9.5	6.61	6.6
M8 x 1.25	1.6-3.1	7.27	7.25	3.1-4.9	7.35	L 7.37	4.6-6.9	7.43	7.4	6.9-8.9	7.47	M 7.49	8.9-10.9	7.51	7.5
M10 x 1.5	1.9-3.9	9.12	23/64 9.1	3.9-5.9	9.22	9.25	5.9-8.3	9.32	9.3	8.3-10.9	9.37	U 9.35	10.9-12.9	9.41	9.4
M12 x 1.75	2.4-4.9	10.98	11.0	4.9-7.4	11.09	7/16 11.11	7.4-10.5	11.2	7/16 11.11	10.5-14.5	11.26	11.3	14.5-17.0	11.31	11.3

Inch Sizes (inches)

Application Duty Class	Light 0.3 Diameter of Material			Medium-Light 0.5 Diameter of Material			Medium-Heavy 0.75 Diameter of Material			Full Strength 1.0 Diameter of Material			Extended 1.25 Diameter of Material		
	90%			80%			70%			65%			60%		
Percentage of Thread	Material Thickness	Pilot Hole	Drill Size	Material Thickness	Pilot Hole	Drill Size	Material Thickness	Pilot Hole	Drill Size	Material Thickness	Pilot Hole	Drill Size	Material Thickness	Pilot Hole	Drill Size
2-56	.017-.034	0.0756	1.9mm 0.0748	.034-.052	0.0767	1.95mm 0.0763	.052-.073	0.0779	5/64 0.0781	.073-.095	0.0785	#47 0.0785	.095-.169	0.0790	2mm 0.0787
3-48	.020-.040	0.08680	2.2mm 0.0866	.040-.059	0.0882	#43 0.089	.059-.084	0.0895	#43 0.089	.084-.110	0.0902	2.3mm 0.0906	.110-.141	0.0909	2.3mm 0.0906
4-40	.022-.045	0.0974	#40 0.098	.045-.067	0.0990	#39 0.0995	.067-.095	0.1006	#39 0.0995	.095-.126	0.1014	#38 0.1015	.126-.157	0.1023	2.6mm 0.0906
5-40	.025-.051	0.1104	2.8mm 0.1102	.051-.075	0.1120	#33 0.113	.075-.106	0.1136	#33 0.113	.106-.141	0.1144	2.9mm 0.1142	.141-.175	0.1153	2.9mm 0.1142
6-32	.028-.066	0.1197	#31 0.120	.066-.083	0.1218	3.1mm 0.122	.083-.117	0.1238	1/8 0.125	.117-.152	0.1248	1/8 0.125	.152-.193	0.1258	3.2mm 0.126
8-32	.033-.066	0.1457	3.7mm 0.1457	.066-.098	0.1478	3.75mm 0.1476	.098-.141	0.1498	3.8mm 0.1496	.141-1.80	0.1508	3.8mm 0.1491	.180-.230	0.1518	#24 0.152
10-24	.038-.079	0.1656	#19 0.166	.079-.114	0.1683	#18 0.1695	.114-.162	0.1710	11/64 0.1719	.162-.209	0.1724	11/64 0.1719	.209-.266	0.1738	4.4mm 0.1732
10-32	.038-.079	0.1717	11/64 0.1719	.079-.114	0.1738	#17 0.173	.114-.162	.01758	#16 0.177	.162-.209	0.1768	#16 0.177	.209-.266	0.1778	4.5mm 0.1772
12-24	.043-.086	0.1916	#11 0.191	.086-.130	0.1943	#9 0.196	.130-.184	0.1970	5mm 0.1969	.184-.238	0.1984	#8 0.199	.238-.302	0.1998	5.1mm 0.2008
1/4-20	.050-.100	0.2208	#2 0.221	.100-.150	0.2240	5.7mm 0.2244	.150-.213	0.2273	#1 0.228	.213-.275	0.2289	5.8mm 0.2283	.275-.350	0.2309	5.8mm 0.2283
5/16-18	.062-.126	0.2800	7.1mm 0.2795	.126-.188	0.2836	7.2mm 0.2835	.188-.266	0.2872	7.3mm 0.2874	.266-.345	0.2890	L 0.29	.345-.438	0.2908	7.4mm 0.2913
3/8-16	.075-.150	0.3384	8.6mm 0.3386	.150-.225	0.3425	8.7mm 0.3425	.225-.319	0.3466	8.8mm 0.3465	.319-.413	0.3486	Size 0.348	.413-.525	0.3506	8.9mm 0.3504
7/16-14	.087-.174	0.3957	X 0.397	.174-.262	0.4004	X 0.397	.262-.371	.04050	Y 0.404	.371-.481	0.4073	13/32 0.4063	.481-.612	0.4096	13/32 0.4063
1/2-13	.100-.200	0.4550	29/64 0.4531	.200-.300	0.4600	29/64 0.4531	.300-.425	0.4650	15/32 0.4688	.425-.550	0.4675	15/32 0.4688	.550-.700	0.4700	15/32 0.4688

APPLICATION DUTY CLASS - A general term used here to group material thickness in terms of screw diameters. For example, the average material thickness listed under "medium-heavy" equals 75% of the screw diameter.

TAPTITE 2000® Screws and Bolts



Recommended extruded pilot hole sizes in light-gauge steel for TAPTITE 2000® Screws and Bolts

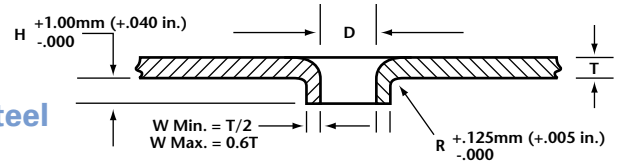

Metric Sizes (mm)

Material Thickness	0.5 - 0.69	0.7 - .99	1.0 - 1.49	1.5 - 2.49	2.5 - 3.0
Screw Size	Hole Size Diameter - D				
M2.5 x .045	2.22	2.23	2.24	—	—
M3 x 0.5	2.70	2.71	2.72	—	—
M4 x 0.7	3.57	3.59	3.61	3.64	—
M5 x 0.8	—	4.53	4.56	4.59	—
M6 x 1.0	—	5.42	5.45	5.48	5.51
M8 x 1.25	—	—	7.27	7.31	7.35

Extruding holes for fasteners in light-gauge steel nearly doubles the length of thread engagement over the original material thickness.

Taptite 2000® screws and bolts develop almost twice the failure torque in extruded holes, providing maximum joint integrity.

Example: The chart shows that for a M4 x 0.7 screw in a material thickness of 0.75mm the suggested hole diameter is 3.59mm. The corresponding "H" dimension is the 1.35mm minimum, making the total length of engagement 2.1mm minimum.

Approximate Material Thickness "T"										
Metric	0.6 - 1.0		1.0 - 1.2		1.2 - 2.0		2.0 - 2.5		2.5 - 3.0	
Hole Dia.-D	H	R	H	R	H	R	H	R	H	R
2.00 - 2.55	1.00	0.13	1.00	0.13	1.00	0.15	1.10	0.25	—	—
2.56 - 3.20	1.20	0.13	1.20	0.13	1.20	0.15	1.30	0.25	1.35	0.25
3.21 - 3.80	1.35	0.13	1.35	0.13	1.35	0.15	1.50	0.25	1.60	0.25
3.81 - 4.60	—	—	1.50	0.13	1.55	0.15	1.80	0.25	1.90	0.25
4.61 - 5.60	—	—	1.80	0.13	1.80	0.15	2.30	0.25	2.40	0.25
5.61 - 6.60	—	—	—	—	1.90	0.15	2.55	0.25	2.65	0.25
6.61 - 7.60	—	—	—	—	2.10	0.15	2.95	0.25	3.20	0.25

Inch Sizes (inches)

Material Thickness	.020 - .029	.030 - .039	.040 - .059	.060 - .099	.100 - .130
Screw Size	Hole Size Diameter - D				
4-40	0.097	0.097	0.098	—	—
6-32	0.119	0.120	0.121	0.122	—
8-32	0.145	0.146	0.147	0.148	—
10-24	0.164	0.166	0.168	0.170	0.170
10-32	0.171	0.172	0.173	0.174	0.174
1/4-20	—	0.221	0.223	0.225	0.225
5/16-18	—	—	0.282	0.285	0.285

Approximate Material Thickness "T"										
Inch	0.020 - 0.035		0.035 - 0.050		0.050 - 0.075		0.075 - .100		0.100 - 0.125	
Hole Dia. D	H	R	H	R	H	R	H	R	H	R
.081 - .100	0.040	0.005	0.040	0.005	0.040	0.006	0.043	0.010	—	—
.101 - .125	0.047	0.005	0.047	0.005	0.047	0.006	0.052	0.010	0.054	0.010
.126 - .150	0.053	0.005	0.053	0.005	0.053	0.006	0.060	0.010	0.063	0.010
.151 - .180	—	—	0.060	0.005	0.060	0.006	0.070	0.010	0.075	0.010
.181 - .220	—	—	0.070	0.005	0.070	0.006	0.090	0.010	0.095	0.010
.221 - .260	—	—	—	—	0.075	0.006	0.100	0.010	0.105	0.010
.261 - .300	—	—	—	—	0.083	0.006	0.116	0.010	0.125	0.010



TAPTITE 2000® CA™ Fasteners

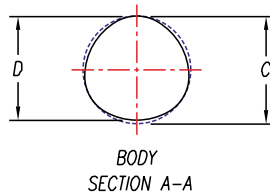

The CA point can be supplied with a sharp point or a slightly truncated blunt point – which is desirable for situations when the sharp point could be a potential hazard to wires, components or assembly line and service personnel.

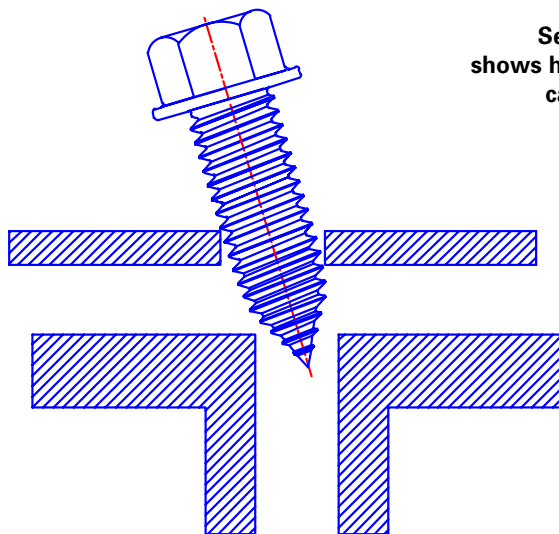
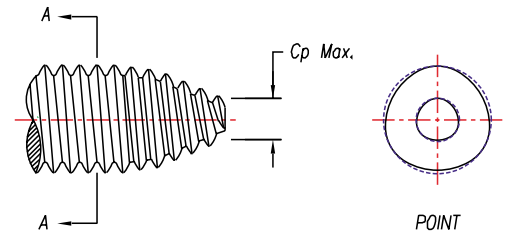
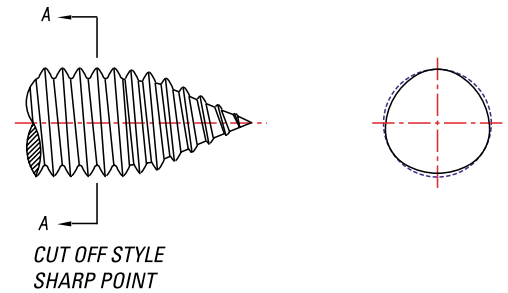
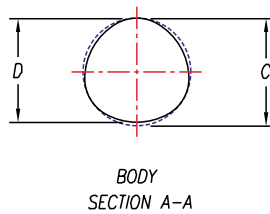

Section view shows hole-finding capability of CA Point.

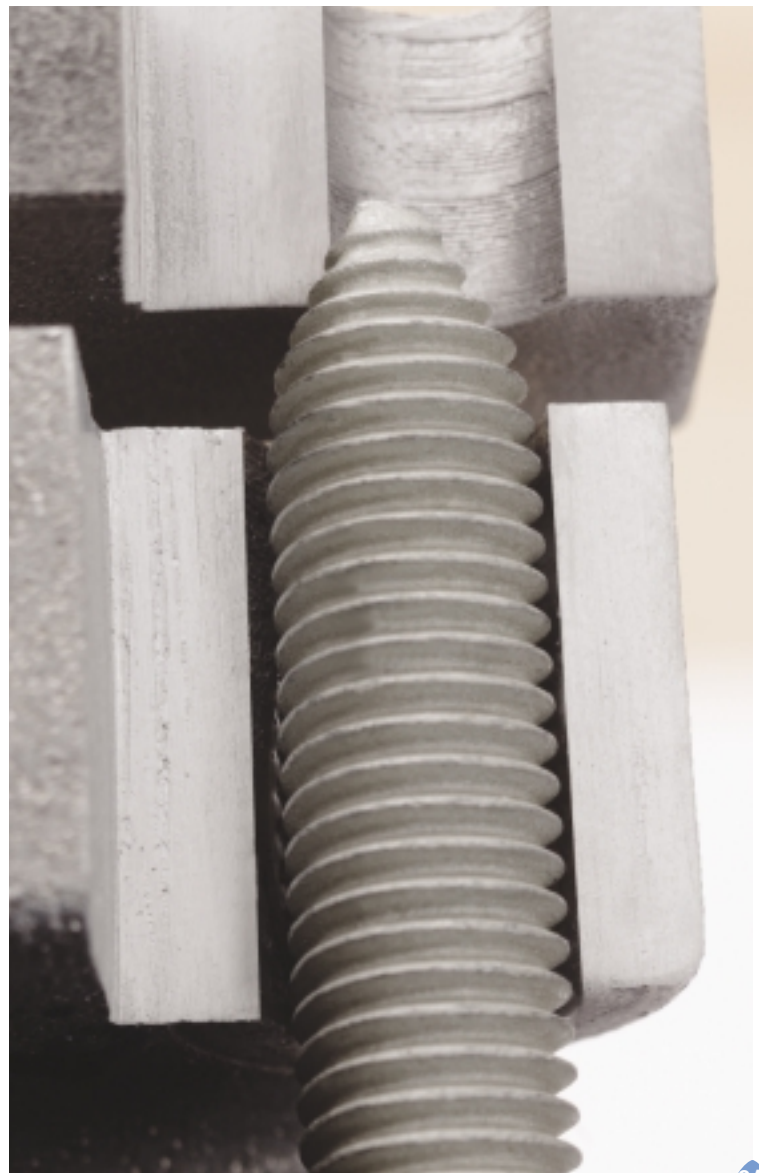

TAPTITE 2000® CA Fasteners have a gimlet point for use when clearance holes and pilot holes do not align.

The CA point is also good for rapid hole finding, floating nut members or difficult access applications.

TAPTITE 2000® CA Fasteners can be produced with any of our heat treatment processes; case hardened – our standard heat treatment for sizes M5 (#12) or smaller, CORFLEX®-I induction hardened for structural or demanding applications or CORFLEX®-N, neutral hardened non-ferrous applications.

See page 2 for a more detailed description of the available heat treat options.



TAPTITE 2000® "SP"™ Fasteners

TAPTITE 2000® "SP"™ Fasteners have a shorter point than standard TAPTITE 2000® fasteners to maximize full thread engagement in blind holes, particularly in non-ferrous materials.

TAPTITE 2000® "SP"™ Fasteners are primarily used in aluminum and therefore are supplied with CORFLEX®-N heat treatment to minimize the potential of stress corrosion. When used in steel material, TAPTITE 2000® "SP"™ Fasteners can be ordered with the case hardened or CORFLEX®-I heat treatment – see page 2 for details.

The short point of the TAPTITE 2000® "SP"™ Fastener maximizes the amount of full thread engagement in blind holes. Increasing the full thread engagement is often critical in shallow depth holes. In many cases the failure mode can be shifted from internal thread stripping to fastener fracture, which is typically desired in castings. In deeper holes, the shorter "SP"™ point may allow a shorter fastener, saving weight and cost.

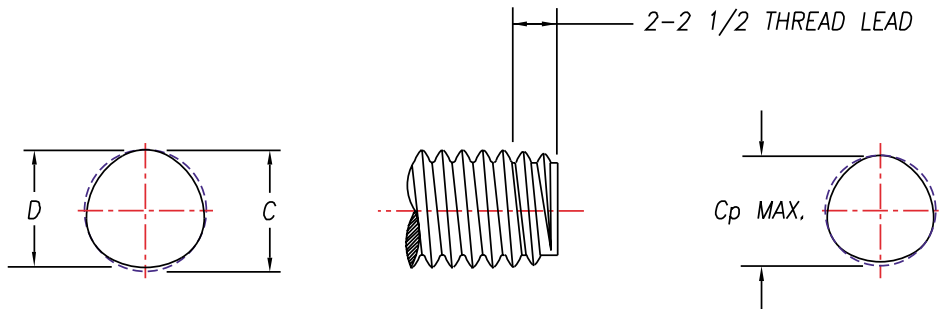

Note: "SP"™ designates Short Point



TAPTITE 2000® "SP"™ Screws and Bolts



Shanghai Autocraft Co., Ltd.
168 Nanlu Highway, Nanhui Industrial Zone,
Shanghai 201300, China

Tel: +86 21 3818 1100
Fax: +86 21 3818 1199

E-mail: sales@autocraft-china.com
Web: www.autocraft-china.com

Recommended pilot hole sizes for Aluminum or Zinc Alloy die castings for TAPTITE 2000® "SP"™ Fasteners

Screw Size	Hole Diameter as Cast				F Hole Dia. as Drilled	L Length of Thread Engagement	H Boss Dia. Min.	J Distance to Edge for No Measurable Distortion Min.
	Top A		Bottom B					
	Max.	Min.	Max.	Min.				
Metric Sizes (mm)								
M2 x 0.40	1.91	1.83	1.81	1.73	1.82	4.00	3.32	1.0
M2.5 x 0.45	2.39	2.31	2.28	2.20	2.29	5.00	4.15	1.2
M3 x 0.5	2.90	2.82	2.76	2.68	2.77	6.00	4.98	1.3
M3.5 x 0.6	3.31	3.23	3.21	3.13	3.23	7.00	5.81	1.6
M4 x 0.7	3.82	3.74	3.64	3.56	3.68	8.00	6.64	1.8
M5 x 0.8	4.80	4.72	4.58	4.50	4.64	10.00	8.30	2.1
M6 x 1.0	5.74	5.66	5.48	5.40	5.54	12.00	9.96	2.6
M7 x 1.0	6.78	6.70	6.48	6.40	6.54	14.00	11.62	2.6
M8 x 1.25	7.69	7.61	7.35	7.27	7.43	16.00	13.28	3.3
M10 x 1.5	9.64	9.56	9.22	9.14	9.32	20.00	16.60	3.9
M12 x 1.75	11.59	11.51	11.09	11.01	11.20	24.00	19.92	4.6
Inch Sizes (inches)								
2-56	0.081	0.078	0.077	0.074	0.0779	0.172	0.197	0.046
3-48	0.093	0.090	0.088	0.085	0.0895	0.198	0.208	0.054
4-40	0.105	0.102	0.099	0.096	0.1006	0.224	0.220	0.065
5-40	0.118	0.115	0.112	0.109	0.1136	0.250	0.232	0.065
6-32	0.128	0.125	0.122	0.119	0.1238	0.276	0.242	0.081
8-32	0.155	0.152	0.148	0.145	0.1498	0.328	0.272	0.081
10-24	0.177	0.174	0.168	0.165	0.1710	0.380	0.315	0.108
10-32	0.182	0.179	0.174	0.171	0.1758	0.380	0.315	0.081
12-24	0.203	0.200	0.194	0.191	0.1970	0.432	0.359	0.108
1/4-20	0.235	0.232	0.224	0.221	0.2273	0.500	0.415	0.130
5/16-18	0.297	0.294	0.284	0.281	0.2872	0.625	0.519	0.144
3/8-16	0.359	0.356	0.343	0.340	0.3466	0.750	0.623	0.162
7/16-14	0.419	0.416	0.400	0.397	0.4050	0.875	0.726	0.186
1/2-13	0.481	0.478	0.460	0.457	0.4650	1.000	0.830	0.200

The minimum length of thread engagement should be equal to twice the diameter of the screw (to approach utilizing available screw strength). The hole diameter, to ensure optimum performance, should provide for 65% to 75% thread engagement.

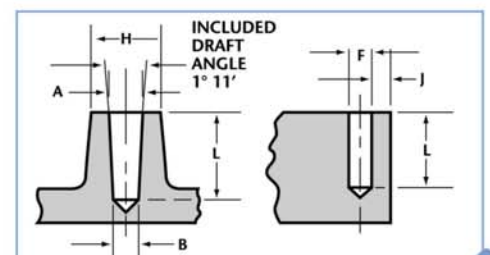

Note; "SP"™ designates Short Point